

Aluhal Event Serie 110

5m - A-frame

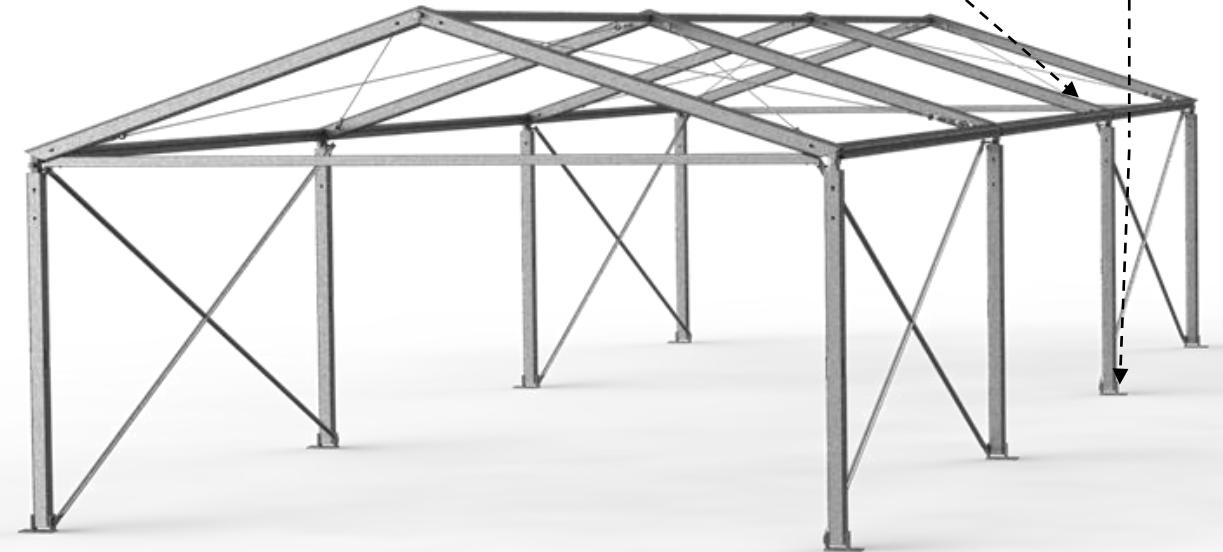

Digital impression; The actual tent will differentiate depending on chosen options

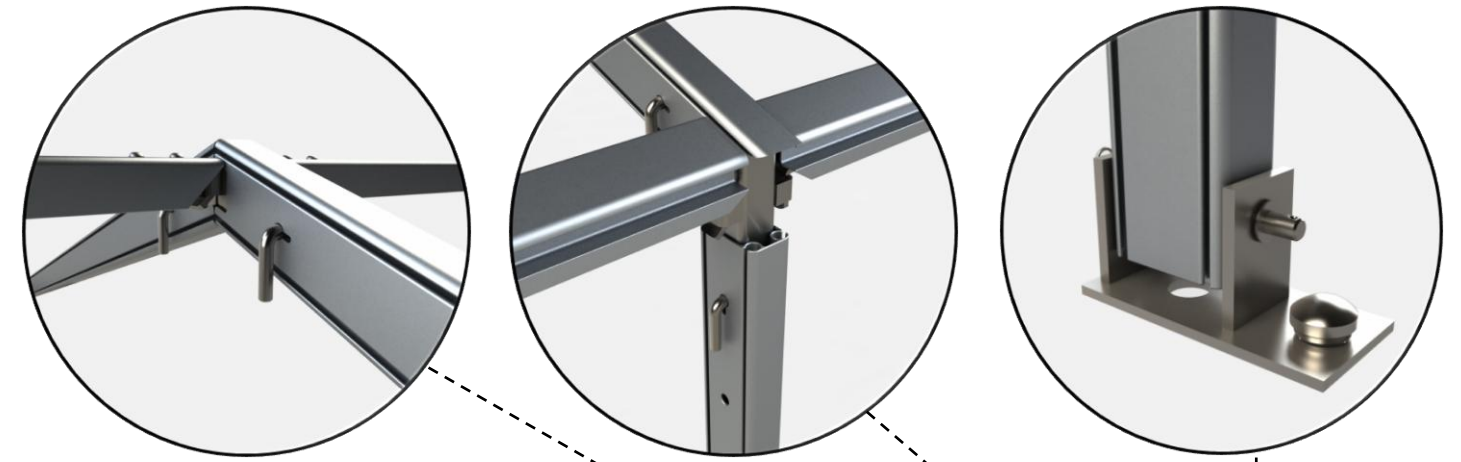
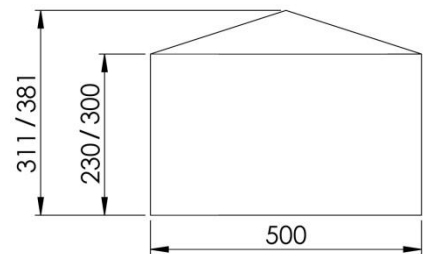

- ✓ **Fast and easy installation by two persons**
- ✓ **Fast delivery from stock**
- ✓ **Inhouse customisation and design**
- ✓ **Compact transport volume**
- ✓ **Constructed according to NEN-EN 13782**

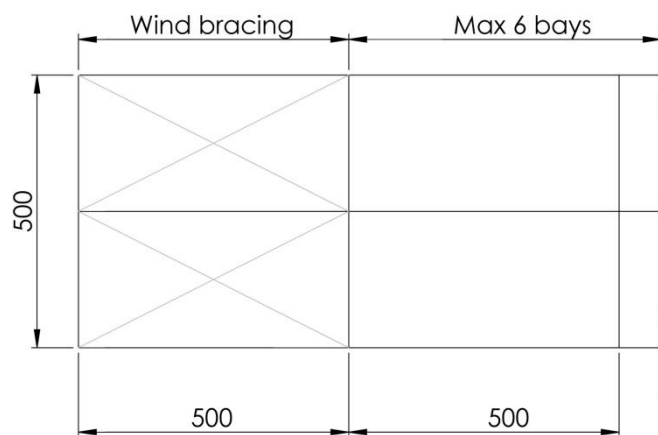

|| Dimensions

Span width:	5.00 m
Eave high:	2.30 / 3.00 m
Ridge high:	3.11 / 3.81 m
Bay distance:	5.00 m
Roof pitch:	18°
Longest component:	5.50 m
Minimum length:	5.00 m
Maximum length:	Unlimited in 5.00m segments
Weight (5 x 15m):	Eave high 2.30m: ~ 850 KG Eave high 3.00m: ~ 900 KG
Transport volume:	5 x 15m: ~ 5.5m ³ (5.5 x 1 x 1m)

|| Specifications

Max allowed wind speed:	80 km/h (0.30kN/m ²), 100 km/h optional
Main profile:	110/68/3 mm (4 channel)
Connecting type:	Steel (galvanized) inserts
Aluminium type:	European anodized Aluminium
Snow load:	Not calculated
PVC roof & wall covers:	Translucent 620gr/m ² or Opaque 750gr/m ² European UV-resistant and flame retardant according to: DIN 4102-B1, M2; BS 5438/7837; USA NFPA701
Included with product:	Set-up instruction manual (click here) Set-up instruction movie (click here) Statics NEN-EN 13782

|| Options

Roof:	- PVC (Translucent/transparent/colour/custom print)
Wall:	- PVC (Translucent/transparent/colour/custom print) - ABS walling (optional: double walls for isolation) - Glass walling (different types)
Doors:	- Single door - Double door
Floor:	- Cassette floor - Heavy duty floor