

Aluhal Event Serie 225

20m - A-frame

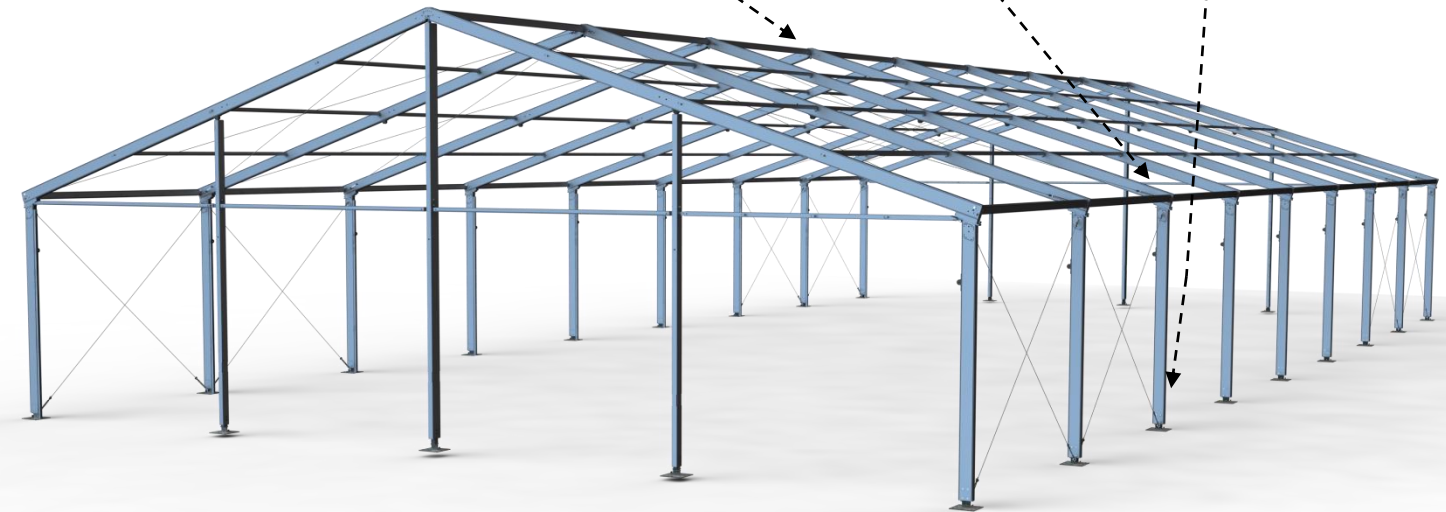

Digital impression; The actual tent will differentiate depending on chosen options

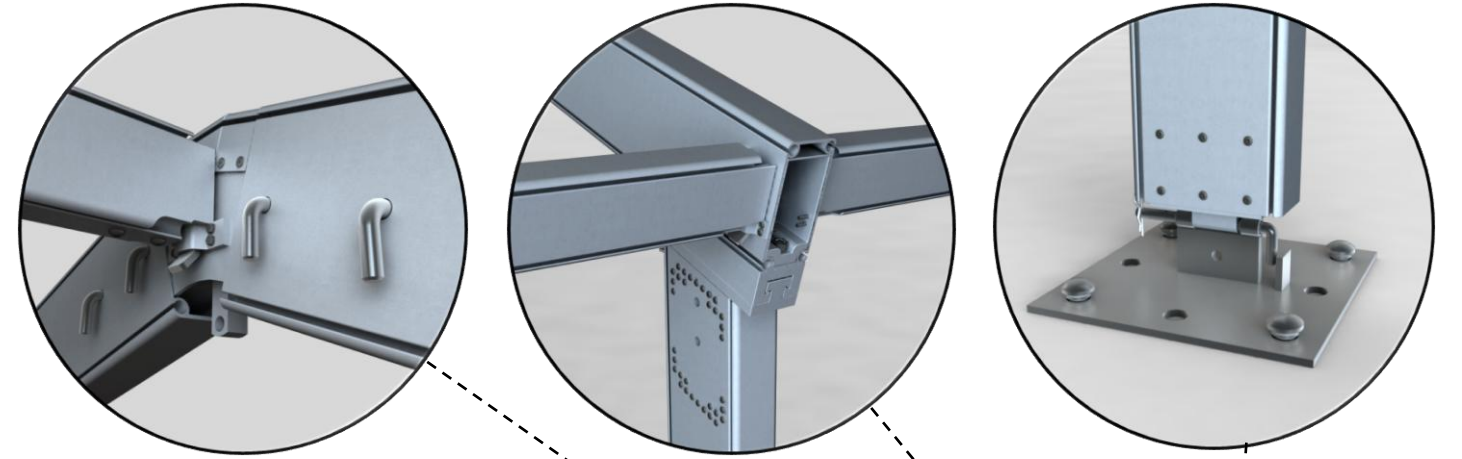
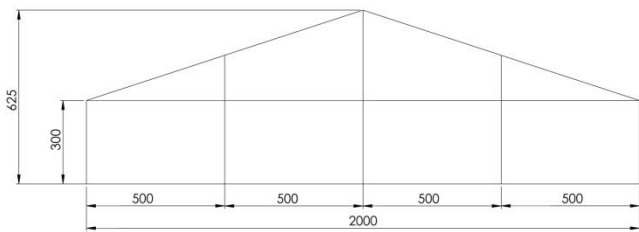

- ✓ **Fast and easy installation**
- ✓ **Fast delivery from stock**
- ✓ **Inhouse customisation and design**
- ✓ **Compact transport volume**
- ✓ **Constructed according to NEN-EN 13782**

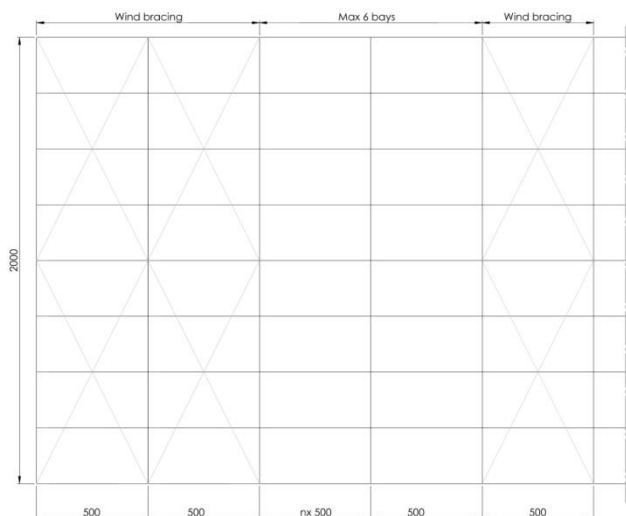

|| Dimensions

Span width:	20.00 m
Eave high:	3.00 m
Ridge high:	6.25 m
Bay distance:	5.00 m
Roof pitch:	18°
Longest component:	10.60 m
Minimum length:	5.00 m
Maximum length:	Unlimited in 5.00m segments
Weight (20 x 40m):	Eave high 3.00m: ~ 5.800 KG
Transport volume:	20 x 40m: ~ 42.40m ³ (10.60 x 2 x 2m)

|| Specifications

Max allowed wind speed:	100 km/h (0.5kN/m ²)
Main profile:	225/101/3.5/5.5 mm (4 channel)
Connecting type:	Steel (galvanized) inserts
Aluminium type:	European anodized Aluminium
Snow load:	Not calculated
PVC roof & wall covers:	Translucent 620gr/m ² or Opaque 750gr/m ²
	European UV-resistant and flame retardant according to: DIN 4102-B1, M2; BS 5438/7837; USA NFPA701
Included with product:	Set-up instruction manual (click here) Set-up instruction movie (click here) Statics NEN-EN 13782

|| Options

Roof:	- PVC (Translucent/transparent/colour/custom print)
Wall:	- PVC (Translucent/transparent/colour/custom print) - ABS walling (optional: double walls for isolation) - Glass walling (different types)
Doors:	- Single door - Double door
Floor:	- Cassette floor - Heavy duty floor